

DC Inverter Air Source Heat Pumps (Monoblock Type)

1. Working source temperature range: -25°C to 45°C
2. Control Object: water tank temperature
(Setting range: Heating: $30^{\circ}\text{C} \sim 55^{\circ}\text{C}$; Cooling: $32^{\circ}\text{C} \sim 12^{\circ}\text{C}$)
3. Control Way: wire controller
4. Water Pump: start/stop according to water tank temp
5. Working Modes: hot water/heating/cooling/hot water+cooling/hot water+heating

SPRSUN

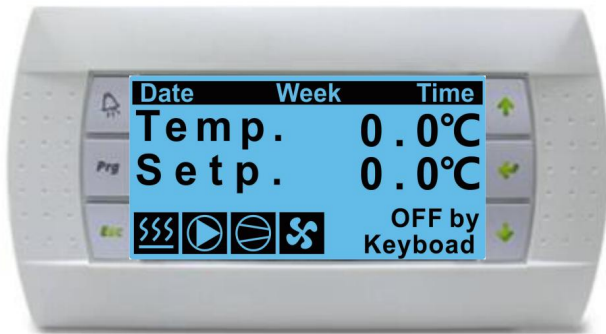

CGK030V3L, CGK-030V3L



CGK050V3L, CGK-050V3L











CGK060V3L, CGK-060V3L



Unit Name		DC Inverter Air Source Heat Pumps (Monoblock Type)											
Model		CGK025V3L	CGK030V3L	CGK040V3L	CGK050V3L	CGK060V3L	CGK-025V3L	CGK-030V3L	CGK-040V3L	CGK-050V3L	CGK-060V3L		
Power Supply / Refrigerant	V/Hz/P	220-240/50/1 - R32	220-240/50/1 - R32	220-240/50/1 - R32	220-240/50/1 - R32	220-240/50/1 - R32	380-420/50/3 - R32	380-420/50/3 - R32	380-420/50/3 - R32	380-420/50/3 - R32	380-420/50/3 - R32		
Max. Heating Capacity (1)	kW	9.5	12	16	20	22	9.5	12	16	20	22		
C.O.P (1)	W/W	4.58	4.45	4.71	4.75	4.62	4.58	4.45	4.71	4.76	4.65		
Heating Capacity Min./Max.(1)	kW	4.37 / 9.5	5.52 / 12	7.36 / 16	9.2 / 20	10.12 / 22	4.37 / 9.5	5.52 / 12	7.36 / 16	9.2 / 20	10.12 / 22		
Heating Power Input Min./Max.(1)	W	763 / 2074	992 / 2697	1250 / 3397	1549 / 4211	1752 / 4762	763 / 2074	992 / 2697	1250 / 3397	1546 / 4202	1741 / 4731		
C.O.P Min./Max.(1)	W/W	4.58 / 5.73	4.45 / 5.56	4.71 / 5.89	4.75 / 5.94	4.62 / 5.78	4.58 / 5.73	4.45 / 5.56	4.71 / 5.89	4.76 / 5.95	4.65 / 5.81		
Max. Heating Capacity(2)	kW	9.1	11.5	15.4	19.2	21.1	9.1	11.5	15.4	19.2	21.1		
C.O.P (2)	W/W	3.71	3.60	3.82	3.85	3.70	3.71	3.60	3.82	3.81	3.60		
Heating Capacity Min./Max.(2)	kW	4.20 / 9.12	5.30 / 11.52	7.07 / 15.36	8.83 / 19.20	9.72 / 21.12	4.20 / 9.12	5.30 / 11.52	7.07 / 15.36	8.83 / 19.20	9.72 / 21.12		
Heating power input Min./Max.(2)	W	964 / 2489	1254 / 3236	1579 / 4076	1957 / 5053	2214 / 5714	964 / 2489	1254 / 3236	1579 / 4076	1953 / 5042	2199 / 5677		
C.O.P Min./Max.(2)	W/W	3.66 / 4.35	3.56 / 4.23	3.77 / 4.47	3.80 / 4.51	3.70 / 4.39	3.66 / 4.35	3.56 / 4.23	3.77 / 4.47	3.81 / 4.52	3.72 / 4.42		
Max. Cooling Capacity(3)	kW	8.7	10.9	14.6	18.2	20.1	8.7	10.9	14.6	18.2	20.1		
E.E.R (3)	W/W	3.60	3.50	3.70	3.73	3.59	3.60	3.50	3.70	3.69	3.50		
Cooling Capacity Min./Max.(3)	kW	3.99 / 8.66	5.03 / 10.94	6.71 / 14.59	8.39 / 18.24	9.23 / 20.06	3.99 / 8.66	5.03 / 10.94	6.71 / 14.59	8.39 / 18.24	9.23 / 20.06		
Cooling Power Input Min./Max.(3)	W	935 / 2849	1215 / 3704	1531 / 4666	1897 / 5783	2146 / 6540	935 / 2849	1215 / 3704	1531 / 4666	1893 / 5771	2132 / 6498		
E.E.R Min./Max.(3)	W/W	3.04 / 4.26	2.95 / 4.14	3.13 / 4.39	3.15 / 4.42	3.07 / 4.30	3.04 / 4.26	2.95 / 4.14	3.13 / 4.39	3.16 / 4.43	3.09 / 4.33		
Max. Cooling Capacity(4)	kW	6.8	8.6	11.5	14.4	15.8	6.8	8.6	11.5	14.4	15.8		
E.E.R(4)	W/W	2.70	2.62	2.78	2.80	2.69	2.70	2.62	2.78	2.77	2.62		
Cooling Capacity Min./Max.(4)	kW	3.15 / 6.84	3.97 / 8.64	5.30 / 11.52	6.62 / 14.40	7.29 / 15.84	3.15 / 6.84	3.97 / 8.64	5.30 / 11.52	6.62 / 14.40	7.29 / 15.84		
Cooling Power Input Min./Max.(4)	W	839 / 2646	1090 / 3440	1373 / 4334	1702 / 5371	1925 / 6075	839 / 2646	1090 / 3440	1373 / 4334	1699 / 5360	1913 / 6036		
E.E.R Min./Max.(4)	W/W	2.58 / 3.75	2.51 / 3.65	2.66 / 3.86	2.68 / 3.89	2.61 / 3.79	2.58 / 3.75	2.51 / 3.65	2.66 / 3.86	2.69 / 3.90	2.62 / 3.81		
Rated Current	A	9.9	12.9	16.3	20.1	22.8	4.4	5.7	7.2	8.9	10.0		
Max Power Input	kW	3.0	3.9	4.9	6.1	6.9	3.0	3.9	4.9	6.1	6.9		
Max Current	A	14.39	18.71	23.57	29.21	33.04	6.35	8.25	10.39	12.86	14.48		
Compressor	Type - Quantity/System	Twin Rotary - 1	Twin Rotary - 1	Twin Rotary - 1	Twin Rotary - 1	Twin Rotary - 1	Twin Rotary - 1	Twin Rotary - 1	Twin Rotary - 1	Twin Rotary - 1	Twin Rotary - 1		
Fan	Quantity	1	1	1	2	2	1	1	1	2	2		
	Airflow	2500	3000	3500	5000	5500	2500	3000	3500	5000	5500		
	Rated power	W	80	100	120	200	210	80	100	120	210		
Water Side Heat Exchanger	Type	Plate Heat Exchanger	Plate Heat Exchanger	Plate Heat Exchanger	Plate Heat Exchanger	Plate Heat Exchanger	Plate Heat Exchanger	Plate Heat Exchanger	Plate Heat Exchanger	Plate Heat Exchanger	Plate Heat Exchanger		
	Water Pressure Drop	kPa	18	20	21	23	25	18	20	21	23		
	Piping Connection	Inch	G1"	G1"	G1"	G1"	G1"	G1"	G1"	G1"	G1"		
Allowable Water Flow	Min./Rated./Max.	L/S 0.28 0.45 0.76	0.36 0.57 0.96	0.48 0.76 1.27	0.60 0.96 1.59	0.66 1.05 1.75	0.28 0.45 0.76	0.36 0.57 0.96	0.48 0.76 1.27	0.60 0.96 1.59	0.66 1.05 1.75		
Noise Level	dB(A)	56	59	60	61	62	56	59	60	61	62		
Net Dimension(L×D×H)	mm	1110*475*810	1110*475*810	1110*475*960	1110*475*1355	1110*475*1355	1110*475*810	1110*475*810	1110*475*960	1110*475*1355	1110*475*1355		
Packing Dimension(L×D×H)	mm	1200*540*970	1200*540*970	1200*540*1120	1200*540*1510	1200*540*1510	1200*540*970	1220*540*970	1200*540*1120	1200*540*1510	1200*540*1510		
Net Weight	Kg	78	88	98	124	124	78	88	98	124	124		
Gross Weight	Kg	106	116	126	161	161	106	116	126	161	161		
Note: (1) Heating condition: water inlet/outlet temperature: 30℃/35℃, Ambient temperature: DB 7℃/WB 6℃;													
(2) Heating condition: water inlet/outlet temperature: 40℃/45℃, Ambient temperature: DB 7℃/WB 6℃;													
(3) Cooling condition: water inlet/outlet temperature: 23℃/18℃, Ambient temperature: DB35℃/WB24℃;													
(4) Cooling condition: water inlet/outlet temperature: 12℃/7℃, Ambient temperature: DB35℃/WB24℃;													

Installation Diagram

Symbol	Name
	3-way valve
	2-way valve
	Ball valve
	Non-return valve
	Filter
	Water pump
	Temp sensor
	Release valve
	Expansion tank

Notice:

1. Pls select the right modes according to your demand then install it according to the installation diagram. If only hot water function required, pls select heating+hot water mode , and then put the hot water sensor into the hot water tank.
2. Two-way valve and BV valve are optional for installation. Only If you need to control the temperature by different zone, then pls install both.
3. Fan coil can be controlled by linkage with the secondary circulation pump . Meanwhile, a passive linkage thermostat shall be installed.

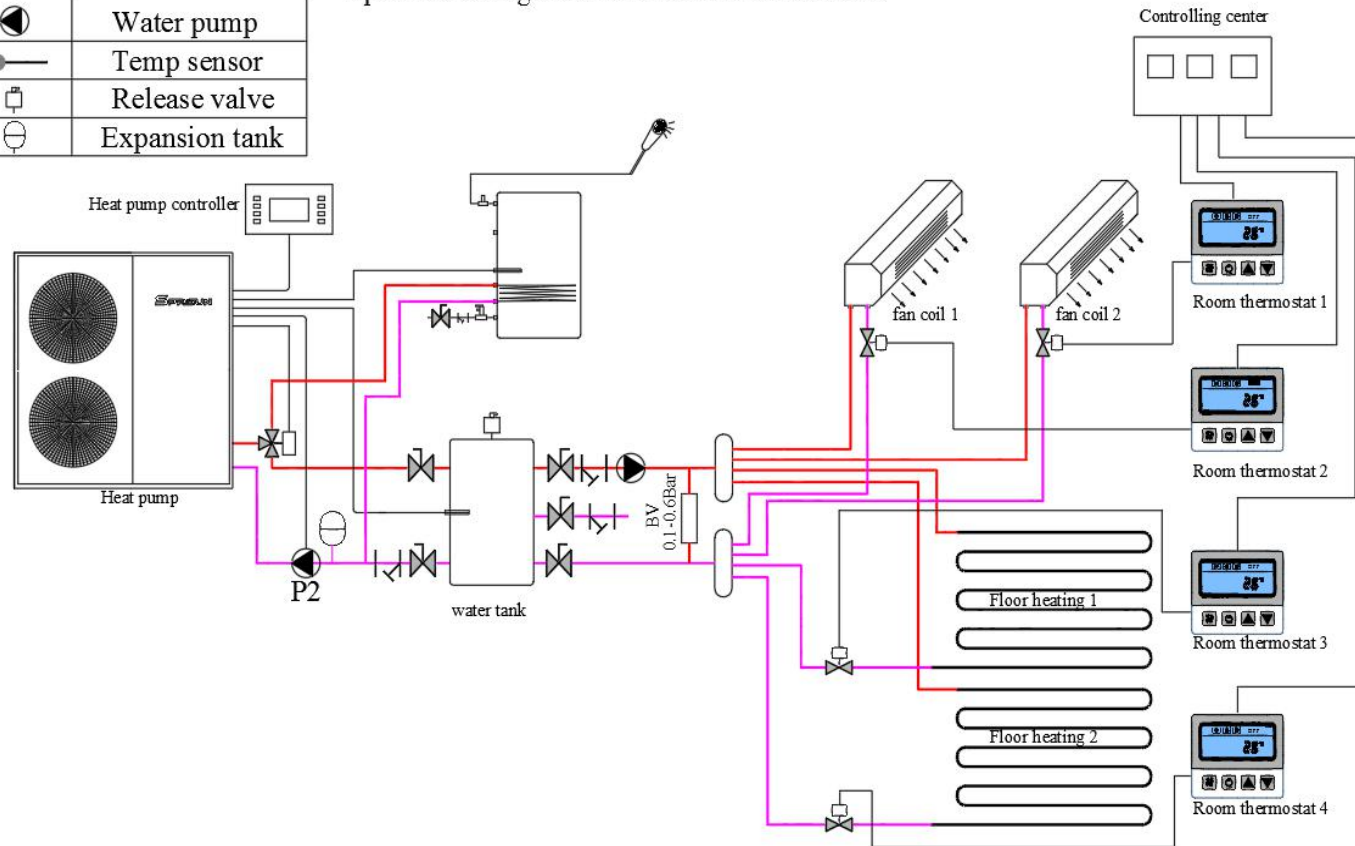

SPRSUN DC inverter air source heat pump



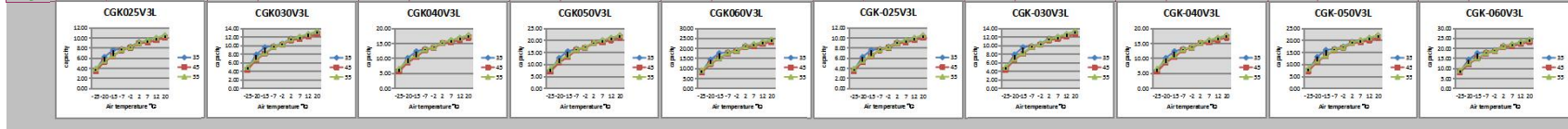



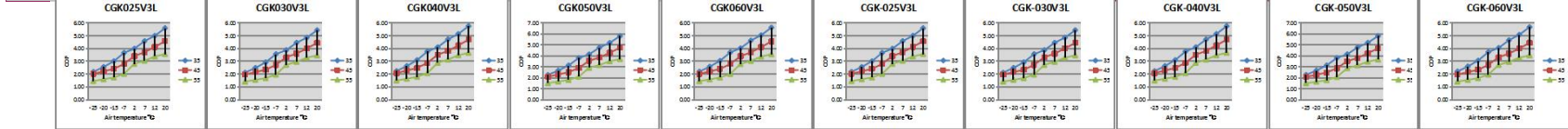

Heating Capacity at Different Conditions																								
Model	CGK025V3L			CGK030V3L			CGK040V3L			CGK050V3L			CGK060V3L											
Air temp. °C	Heating capacity (kW)			Heating capacity (kW)			Heating capacity (kW)			Heating capacity (kW)			Heating capacity (kW)											
-25	3.61	3.44	3.92	4.36	4.35	4.95	5.87	6.59	6.80	7.31	6.99	8.20	8.37	7.97	9.48	9.61	9.44	9.92	10.56	10.39	10.88	11.81	11.64	12.13
-20	6.25	6.30	6.92	7.89	8.69	8.97	10.15	8.60	9.30	10.69	10.35	11.62	14.47	12.28	12.78	16.25	16.30	16.92	17.89	17.94	18.56	20.15	19.98	20.48
-15	7.82	6.46	6.57	9.62	8.16	8.30	12.38	10.89	11.07	16.48	13.11	13.84	17.65	14.95	15.22	21.62	18.46	18.73	23.82	21.16	21.43	27.89	25.23	25.50
-7	7.82	7.60	7.73	9.88	9.60	9.77	13.18	12.79	13.02	16.47	15.99	16.28	18.12	17.69	17.91	21.82	21.39	21.61	25.00	24.57	24.79	28.18	27.75	27.97
-2	8.29	8.01	8.19	10.47	10.18	10.34	13.69	13.35	13.79	17.00	16.63	17.23	19.39	18.96	19.56	22.29	21.84	22.44	24.68	24.23	24.83	27.07	26.62	27.22
2	9.21	8.94	9.10	11.63	11.29	11.49	15.20	15.05	15.32	19.00	18.82	19.15	21.32	20.70	21.07	24.21	23.59	23.96	27.12	26.50	26.87	30.03	29.41	29.78
7	9.50	9.12	9.58	12.00	11.52	12.10	16.00	15.36	16.13	20.00	19.20	20.16	22.00	21.12	22.18	24.00	23.00	24.00	26.00	25.00	26.00	28.00	27.00	28.00
12	9.88	9.58	10.05	12.60	12.10	12.70	16.80	16.13	16.93	21.00	20.16	21.17	23.10	22.18	23.28	25.20	24.28	25.38	27.30	26.38	27.48	29.40	28.48	29.58
20	10.47	10.05	10.56	13.23	12.70	13.34	17.64	16.93	17.78	22.05	21.17	22.23	24.26	23.28	24.43	26.47	25.50	26.56	28.68	27.70	28.76	30.89	30.00	31.06
Hot water temp. °C	30/35	40/45	50/55	30/35	40/45	50/55	30/35	40/45	50/55	30/35	40/45	50/55	30/35	40/45	50/55	30/35	40/45	50/55	30/35	40/45	50/55	30/35	40/45	50/55

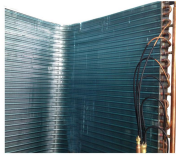

Model	CGK025V3L			CGK030V3L			CGK040V3L			CGK050V3L			CGK060V3L											
Air temp. °C	COP (LW/WH)			COP (LW/WH)			COP (LW/WH)			COP (LW/WH)			COP (LW/WH)											
-25	2.17	2.02	1.43	2.11	1.96	1.41	2.23	2.07	1.49	2.25	2.09	1.50	2.19	2.01	1.45	2.17	2.02	1.45	2.11	1.96	1.41	2.23	2.07	1.49
-20	2.56	2.21	1.59	2.48	2.15	1.55	2.68	2.28	1.64	2.65	2.30	1.65	2.58	2.21	1.59	2.56	2.21	1.59	2.48	2.15	1.55	2.66	2.27	1.64
-15	3.01	2.41	1.73	2.92	2.34	1.68	3.09	2.48	1.78	3.12	2.50	1.80	3.03	2.40	1.73	3.01	2.41	1.73	2.92	2.34	1.68	3.09	2.48	1.78
-7	3.67	2.80	2.02	3.56	2.72	1.96	3.77	2.88	2.07	3.80	2.90	2.09	3.70	2.78	2.01	3.67	2.80	2.02	3.56	2.72	1.96	3.77	2.88	2.07
-2	3.98	3.41	2.80	3.87	3.32	2.72	4.10	3.51	2.88	4.13	3.54	2.90	4.02	3.48	2.79	3.98	3.41	2.80	3.87	3.32	2.72	4.10	3.51	2.88
2	4.48	3.71	3.04	4.45	3.60	2.96	4.71	3.82	3.13	4.75	3.85	3.15	4.62	3.70	3.03	4.58	3.71	3.04	4.45	3.60	2.96	4.71	3.82	3.13
12	4.99	4.12	3.38	4.85	4.00	3.28	5.13	4.23	3.47	5.18	4.27	3.50	5.08	4.10	3.36	4.99	4.12	3.38	4.85	4.00	3.28	5.13	4.23	3.47
20	5.59	4.57	3.57	5.43	4.44	3.46	5.75	4.70	3.67	5.80	4.74	3.70	5.64	4.55	3.55	5.59	4.57	3.57	5.43	4.44	3.46	5.75	4.70	3.67
Hot water temp. °C	35	45	55	35	45	55	35	45	55	35	45	55	35	45	55	35	45	55	35	45	55	35	45	55

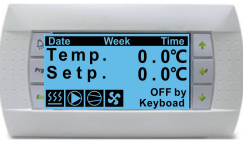

Standard Materials

Name	Description	Picture	Name	Description	Picture	Name	Description	Picture
Condenser	Plate Heat Exchanger		Evaporator	Hydropilic Aluminium foil and internal thread copper pipe heat exchanger		High Pressure Sensor	CAREL 0-4.5MPa	
Compressor	Panasonic Rotary Compressor		Expansion Valve	CAREL Electronic expansion valve		Low Pressure Sensor	CAREL 0-3.45MPa	
4-way valve	SANHUA		DC Fan	WOLONG DC Fan		Package	corrugated board case / plywood case	
Controller	CAREL Controller							

Functions

1. How to Start Electric Heater?

There are two kinds of electric heaters: backup electric heater and crank heater. The corresponding electric heater can be enabled in M04 menu.

In heating mode (without defrosting), start backup electric heater when all the following conditions are met:

- (1) Enable the backup electric heater function;
- (2) Ambient temperature \leq the ambient temperature when starting electric heater (default value 0°C);
- (3) Target temperature \leq heating temperature set point - deviation value under electric heating (default value 5°C);
- (4) It takes more than 5min to start the compressor (adjustable);

In heating mode (without defrosting), turn off backup electric heater if any of the following conditions are met:

- (1) Ambient temperature \geq the ambient temperature when starting electric heater + 3°C ;
- (2) Target temperature \geq heating temperature set point;
- (3) Ambient temperature sensor error;
- (4) Power off.

2. How to Enter Defrosting?

When the air-cooled unit is in the heating mode, the outdoor coil works as evaporator. If the outdoor temperature is too low, frost may form on the coil, which means that the working efficiency of the unit is reduced. In this case, the heating mode should be temporarily switched to the cooling mode for defrosting and then return to the heating mode, so that the unit can resume its high efficiency.

Defrosting Conditions:

Defrosting will be enabled when the following conditions are met at the same time:

- (1) Time between two defrosting cycles \geq defrosting interval, unit: min, default value: 45;
- (2) Ambient temperature \leq defrosting ambient temperature, lasting for 2s, default value is 15°C (this condition is ignored when there is ambient temperature sensor error);
- (3) Ambient temperature - evaporation temperature \geq defrosting temperature difference, lasting for 2s, the default value is 5°C ; this condition is ignored when there is ambient temperature sensor error;
- (4) Evaporation temperature \leq defrosting set point, lasting for 2s, default value -1°C ;

Defrosting set point: according to the compensation of ambient temperature, the lower the ambient temperature is, the lower the setting point will be.

Implementing the manual forced defrosting command will ignore the above entry conditions.

Defrosting will quit if any of the following conditions is met:

- (1) Defrosting time \geq maximum defrosting time, the default value is 8min;
- (2) Condensation/coil temperature \geq the setting point of exiting defrosting, default value 15°C ;
- (3) Power off.